

Infrared Laser Diode

ADL-80Y04TZ
6-2D-LD80-001_Rev.02

808nm 200mW High Power Operation

•Features

1. Low threshold current
2. Low operation current
3. High pumping efficiency
4. Stable wavelength
5. High reliability

•Applications

1. Pumping source for DPSS green laser
2. Medical applications

•Absolute maximum ratings

Parameter	Symbol	Condition	Rating	Unit
Light output power	P_O	CW	200	mW
Reverse voltage (LD)	V_{RL}	-	2	V
Case temperature	T_C	-	-10~+50	°C
Storage temperature	T_S	-	-40~+85	°C

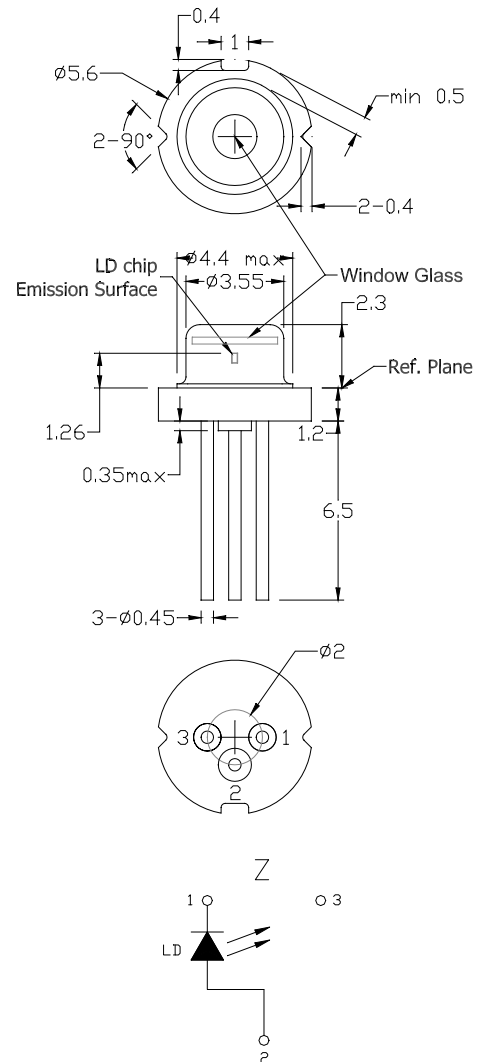

•Electrical and optical characteristics ($T_C=25^\circ\text{C}$)

Parameter	Symbol	Min.	Typ.	Max.	Unit	Conditions (CW)
Peak wavelength	λ	805	808	811	nm	$P_o=200\text{mW}$
Threshold current	I_{th}	-	60	75	mA	
Operating current	I_{op}	-	230	260	mA	
Operating voltage	V_{op}	-	1.9	2.2	V	$P_o=150\text{-}200\text{mW}$
Differential efficiency	η	0.8	1.2	-	mW/mA	
Parallel divergence angle	$\theta_{ }$	-	8	11	deg	$P_o=200\text{mW}$
Perpendicular divergence angle	θ_{\perp}	-	39	48	deg	
Parallel FFP deviation angle	$\Delta\theta_{ }$	-3	0	+3	deg	
Perpendicular FFP deviation angle	$\Delta\theta_{\perp}$	-5	0	+5	deg	
Emission point accuracy	$\Delta x \Delta y \Delta z$	-80	0	+80	um	

•Precautions

- * Do not operate the device above maximum ratings. Doing so may cause unexpected and permanent damage to the device.
- * Take precautions to avoid electrostatic discharge and/or momentary power spikes. A change in the characteristics of the laser or premature failure may result.
- * Proper heat sinking of the device assures stability and lifetime. Always ensure that maximum operating temperatures are not exceeded.
- * Observing visible or invisible laser beams with the human eye directly, or indirectly, can cause permanent damage. Use a camera to observe the laser.
- * No laser device should be used in any application or situation where life or property is at risk in event of device failure.
- * Specifications are subject to change without notice. Ensure that you have the latest specification by contacting us prior to purchase or use of the product.

* For reference only. Contents above are subject to change without notice.

Contact

For US, Canada Ayase America Inc. e-mail: info@ayaseamerica.com +1-408-988-5277
 For EU Ayase Europe GmbH e-mail: info@ayase-europe.de +49-0-6122-533-811
 For Japan Ayase Co., Ltd. e-mail: info@ayasecorporation.com +81-45-532-9501

Infrared Laser Diode

ADL-80Y04TZ
6-2D-LD80-001_Rev.02

Notice: Arima Lasers proposes to operate ADL-80Y04TZ by the external APC circuit

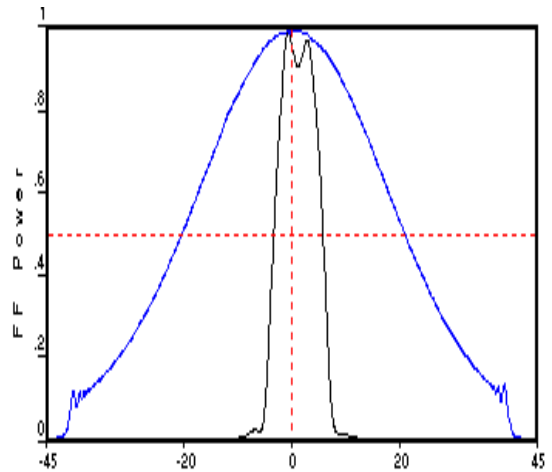
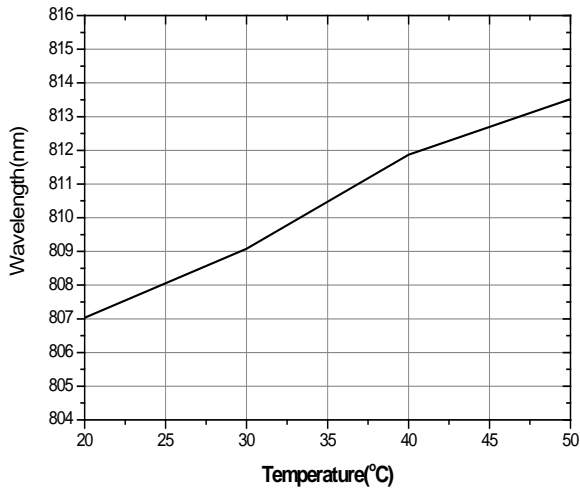
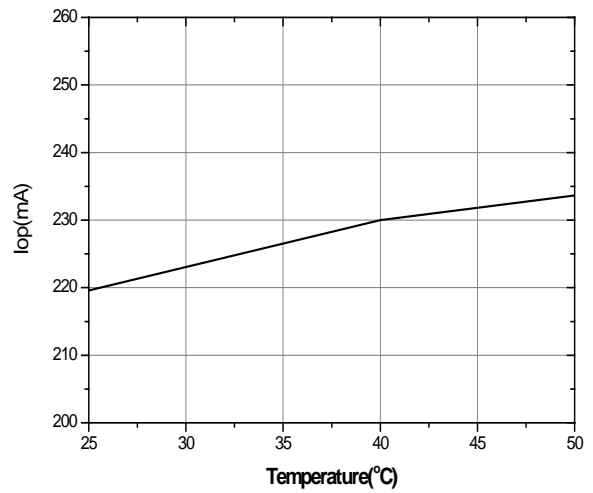
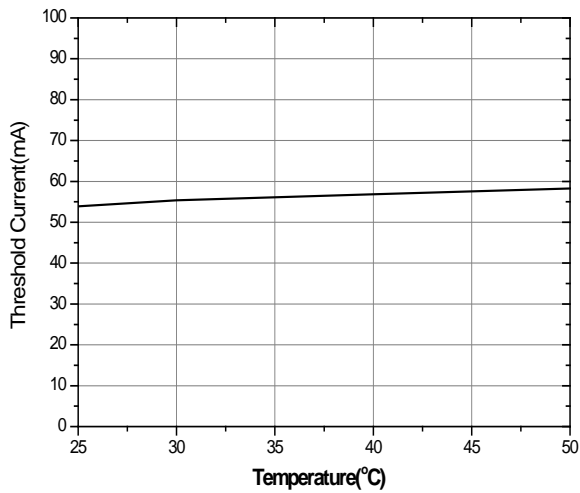
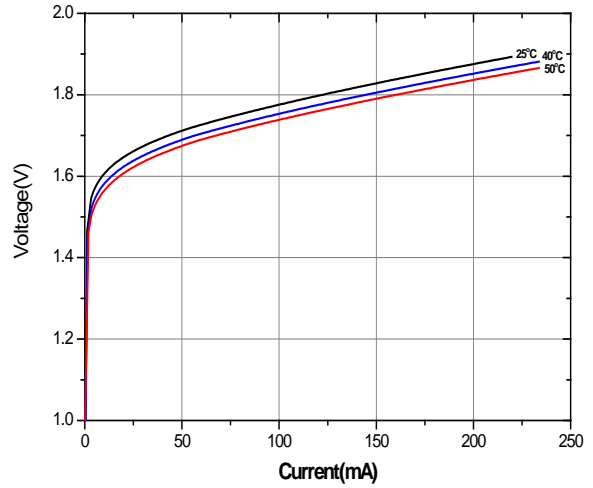
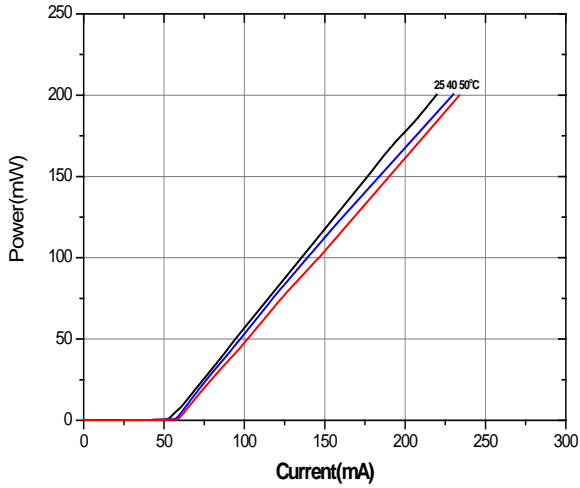

* For reference only. Contents above are subject to change without notice.

Contact

For US, Canada
For EU
For Japan

Ayase America Inc.
Ayase Europe GmbH
Ayase Co., Ltd.

e-mail: info@ayaseamerica.com
e-mail: info@ayase-europe.de
e-mail: info@ayasecorporation.com

+1-408-988-5277
+49-0-6122-533-811
+81-45-532-9501

