

# AlGaInP Visible Laser Diode

ADL-65075TL

6-2D-LD65-012\_Rev.00

★650nm 7mW 70 °C Reliable Operation!

★Ideal for DVD optical pick-up head

•Features

1. Low operating current
2. Higher power
3. High efficiency

•Applications

1. DVD player/ROM optical pick up
2. Combo drive optical pick up
3. Bar code scanner

•Absolute maximum ratings

Parameter	Symbol	Condition	Rating	Unit
Light output power	$P_O$	CW	10	mW
Reverse voltage (LD)	$V_{RL}$	-	2	V
Reverse voltage (PD)	$V_{RD}$	-	30	V
Forward current (PD)	$I_{FD}$	-	10	mA
Case temperature	$T_C$	-	-10~+70	°C
Storage temperature	$T_S$	-	-40~+85	°C

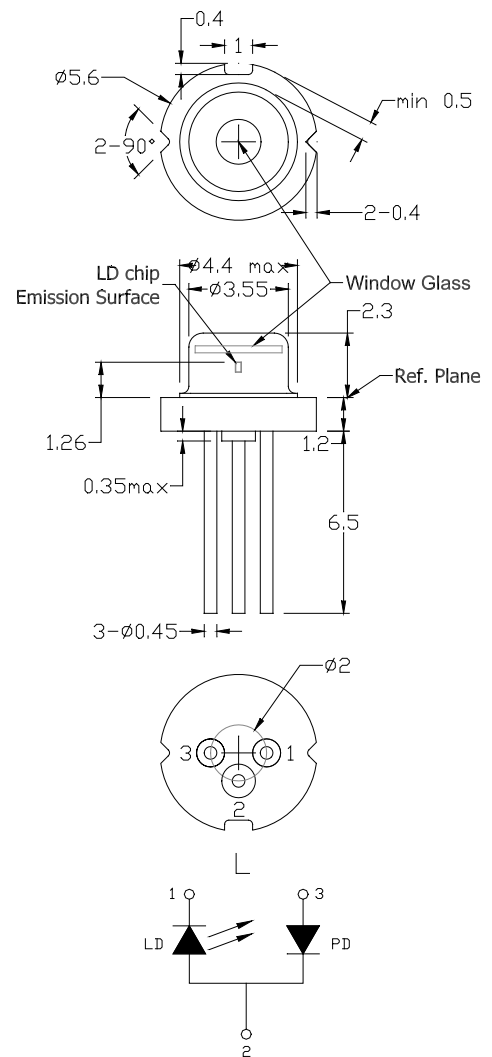

•Electrical and optical characteristics ( $T_c=25\text{ }^\circ\text{C}$ )

Parameter	Symbol	Min.	Typ.	Max.	Unit	Conditions
Peak wavelength	$\lambda$	645	650	660	nm	$P_o=7\text{mW}$
Threshold current	$I_{th}$	-	20	25	mA	
Operating current	$I_{op}$	-	27	35	mA	$P_o=7\text{mW}$
Operating voltage	$V_{op}$	-	2.2	2.5	V	$P_o=7\text{mW}$
Differential efficiency	$\eta$	0.7	1.0	1.2	mW/mA	$P_o=3\text{-}5\text{mW}$
Monitor current	$I_m$	0.1	0.15	0.3	mA	$P_o=7\text{mW}, V_{RD}=5\text{V}$
Parallel divergence angle	$\theta_{  }$	6	9	12	deg	$P_o=7\text{mW}$
Perpendicular divergence angle	$\theta_{\perp}$	25	28	32	deg	
Parallel FFP deviation angle	$\Delta\theta_{  }$	-3	0	+3	deg	
Perpendicular FFP deviation angle	$\Delta\theta_{\perp}$	-3	0	+3	deg	
Emission point accuracy	$\Delta x \Delta y \Delta z$	-80	0	+80	um	

• Precautions

- \* Do not operate the device above maximum ratings. Doing so may cause unexpected and permanent damage to the device.
- \* Take precautions to avoid electrostatic discharge and/or momentary power spikes. A change in the characteristics of the laser or premature failure may result.
- \* Proper heat sinking of the device assures stability and lifetime. Always ensure that maximum operating temperatures are not exceeded.
- \* Observing visible or invisible laser beams with the human eye directly, or indirectly, can cause permanent damage. Use a camera to observe the laser.
- \* No laser device should be used in any application or situation where life or property is at risk in event of device failure.
- \* Specifications are subject to change without notice. Ensure that you have the latest specification by contacting us prior to purchase or use of the product

\* For reference only. Contents above are subject to change without notice.

Contact

For US, Canada Ayase America Inc. e-mail: [info@ayaseamerica.com](mailto:info@ayaseamerica.com) +1-408-988-5277  
 For EU Ayase Europe GmbH e-mail: [info@ayase-europe.de](mailto:info@ayase-europe.de) +49-0-6122-533-811  
 For Japan Ayase Co., Ltd. e-mail: [info@ayasecorporation.com](mailto:info@ayasecorporation.com) +81-45-532-9501

# AlGaInP Visible Laser Diode

ADL-65075TL  
6-2D-LD65-012\_Rev.00

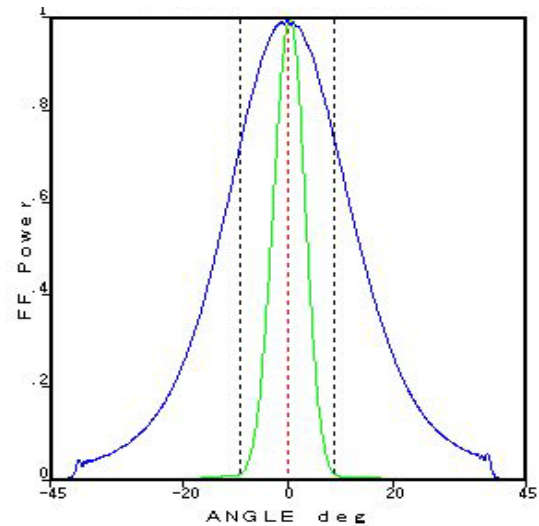
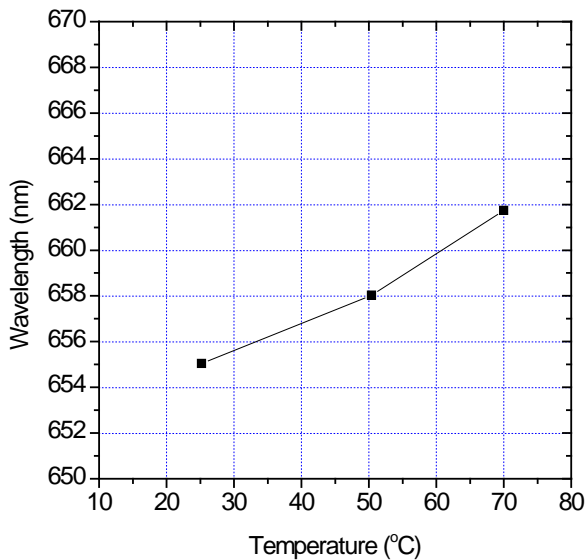
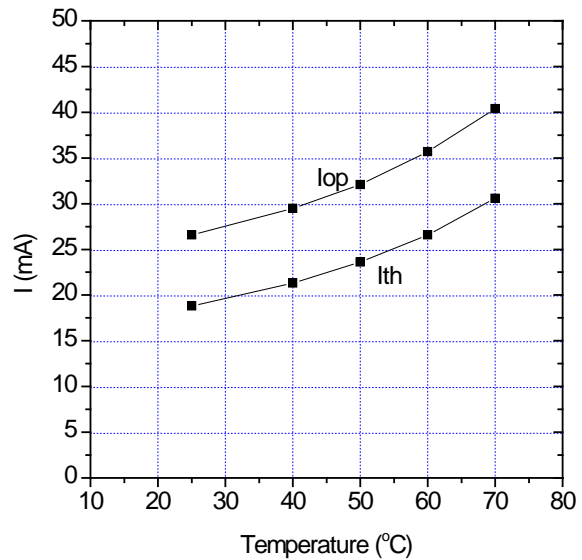
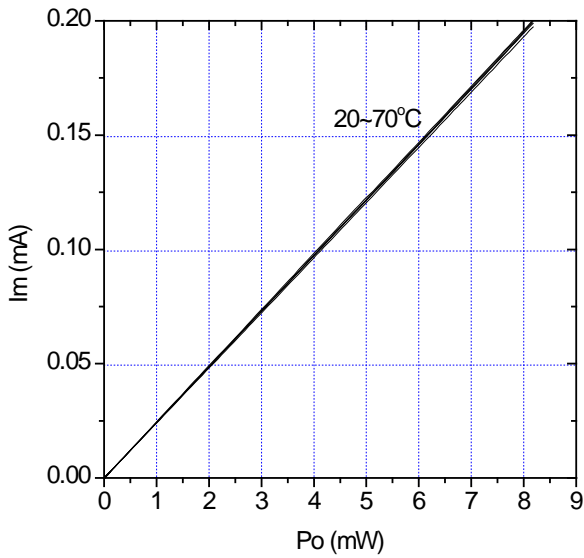
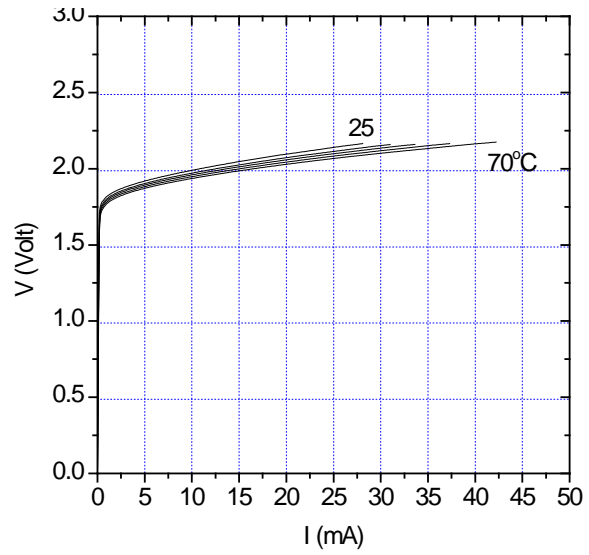
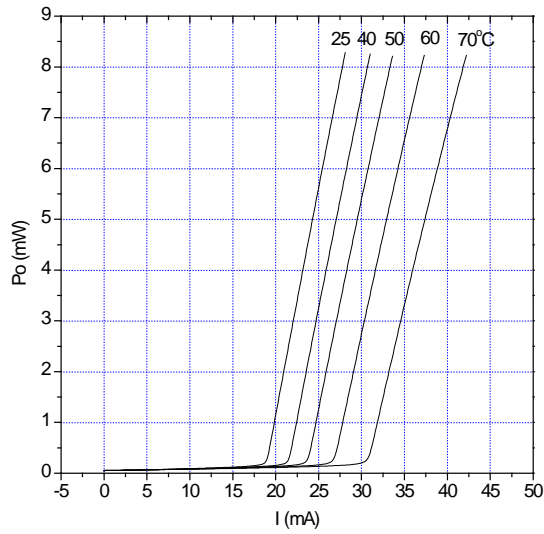

\* For reference only. Contents above are subject to change without notice.

Contact

For US, Canada  
For EU  
For Japan

Ayase America Inc.  
Ayase Europe GmbH  
Ayase Co., Ltd.

e-mail: [info@ayaseamerica.com](mailto:info@ayaseamerica.com)  
e-mail: [info@ayase-europe.de](mailto:info@ayase-europe.de)  
e-mail: [info@ayasecorporation.com](mailto:info@ayasecorporation.com)

+1-408-988-5277  
+49-0-6122-533-811  
+81-45-532-9501

